

Name: _____

Date: _____

Area of Squares, Rectangles, and Parallelograms

Find the area of each.

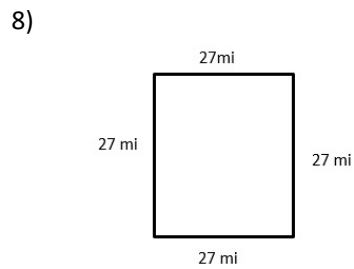
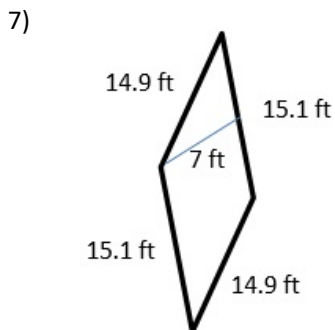
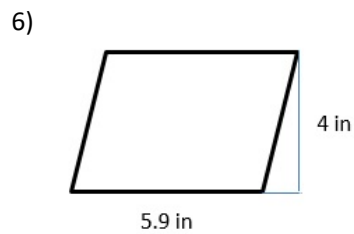
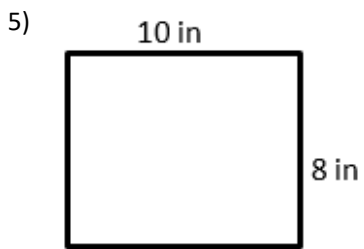
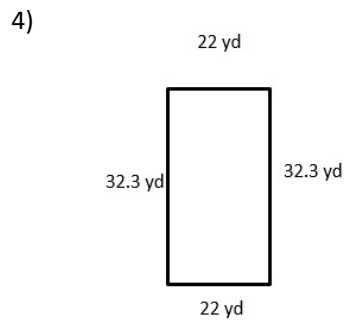
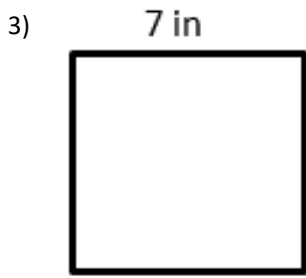
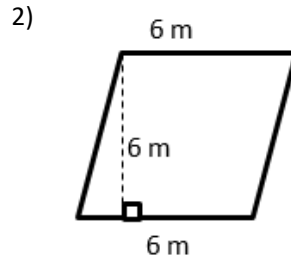
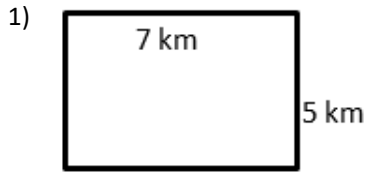



Scan me
for more
PRACTICE

testinar.com/t/?c=14

